

DIN 7985 A4 M 4X16 Z

Cross recessed raised cheese head screws

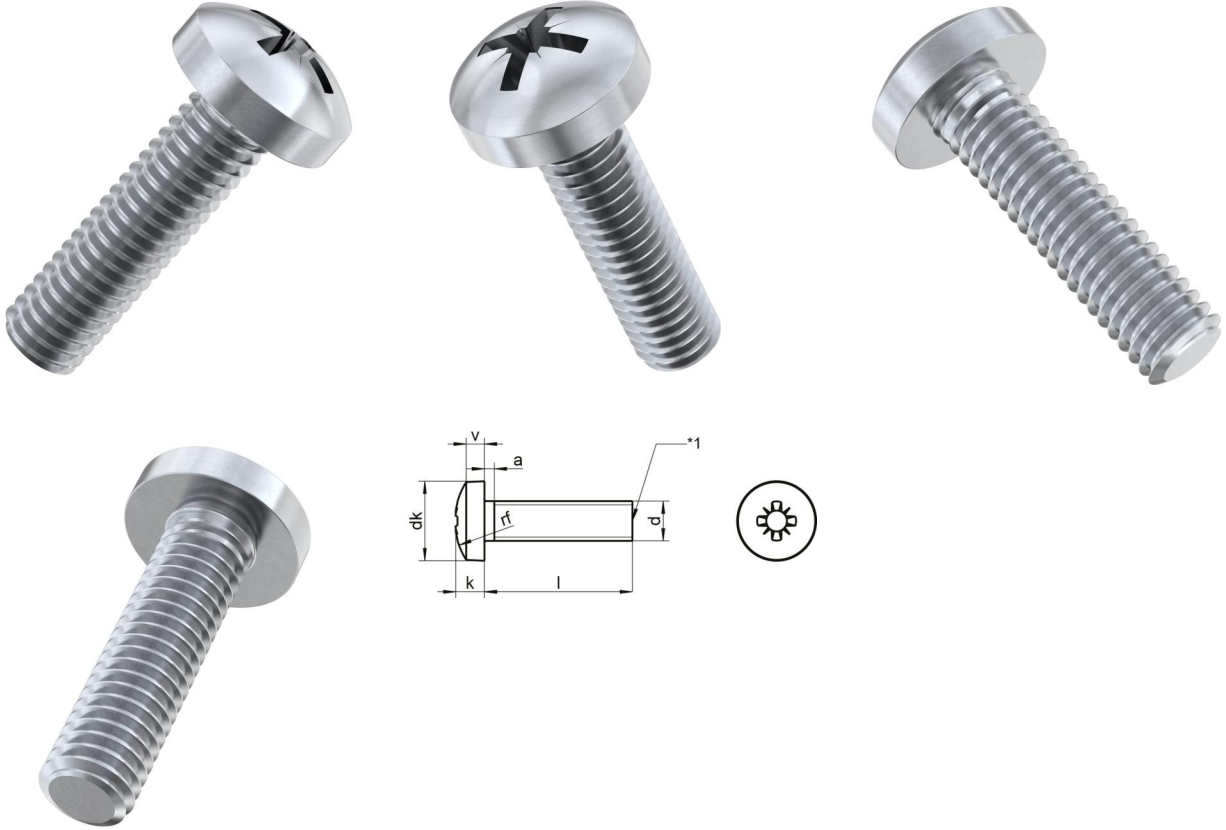

Teknik Veriler / Technical Data

Material	A4
Weight per 100 pcs.	0,23 kg
Packaging	500 pcs.
Length (l)	16 mm
Diameter of head (dk)	8
Height of head (k)	3.1
Drive size	PZ2
Diameter (d)	4 mm
Drive shape	Pozidrive
Thread type	Metric
Head shape	pan head
Tensile strength	500 N/mm2