

DIN 7985 A2 M 6X70 Z

Cross recessed raised cheese head screws

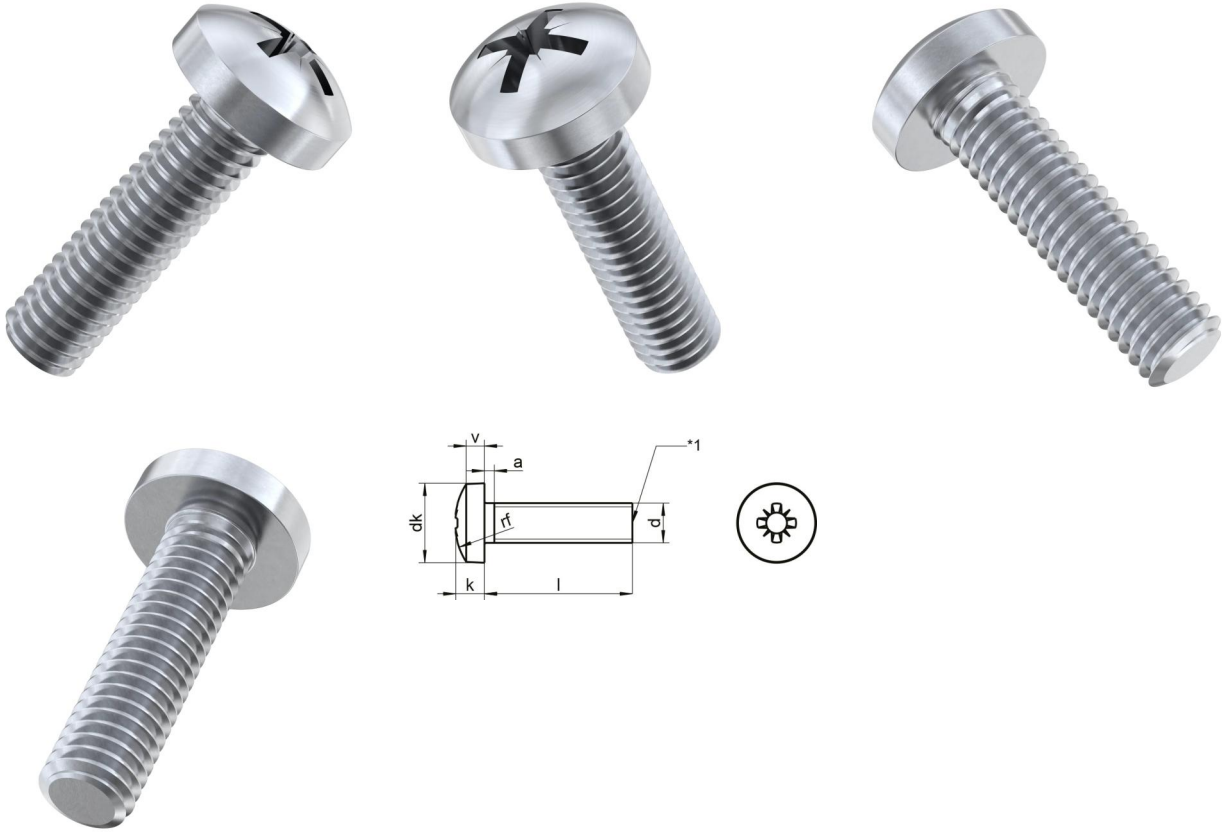

Teknik Veriler / Technical Data

Material	A2
Weight per 100 pcs.	1,59 kg
Packaging	100 pcs.
Alternative product	DIN 7985 A4 M 6X70 Z
Length (l)	70 mm
Diameter of head (dk)	12
Height of head (k)	4.6
Drive size	PZ3
Diameter (d)	6 mm
Drive shape	Pozidrive
Thread type	Metric
Head shape	pan head
Tensile strength	700 N/mm ²