

## DIN 7985 A2 M 4X55 Z

Cross recessed raised cheese head screws

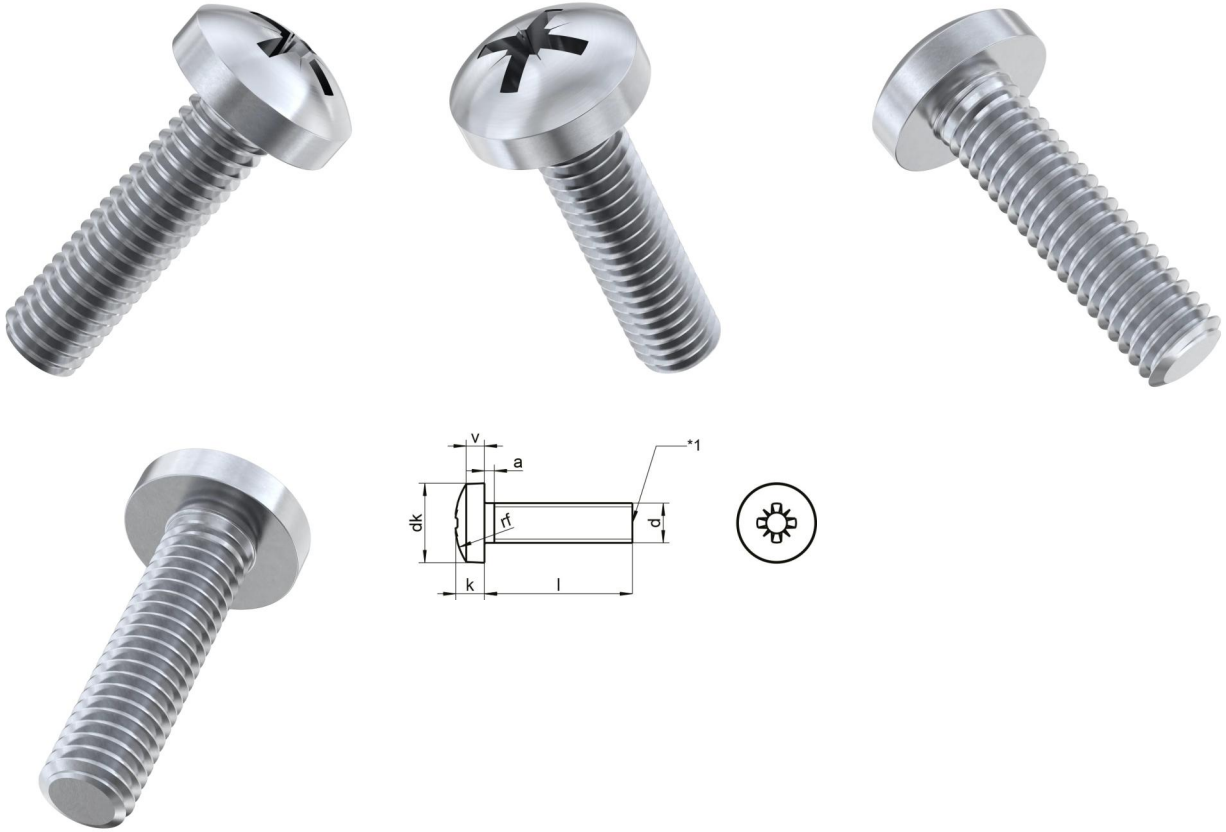

### Teknik Veriler / Technical Data

Material	A2
Weight per 100 pcs.	0,59 kg
Packaging	200 pcs.
Alternative product	DIN 7985 A4 M 4X55 Z
Length (l)	55 mm
Diameter of head (dk)	8
Height of head (k)	3.1
Drive size	PZ2
Diameter (d)	4 mm
Drive shape	Pozidrive
Thread type	Metric
Head shape	pan head
Tensile strength	500 N/mm <sup>2</sup>